

FRONT ELEVATION

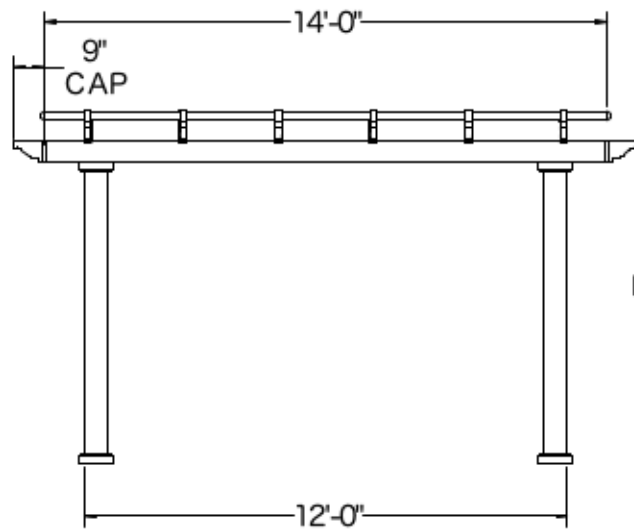

Post on Center Measurement

5" Square Post	139"
7" Square Column	133 1/2"
7" Round Column	133 1/2"
10" Round Column	131 3/4"

SIDE ELEVATION

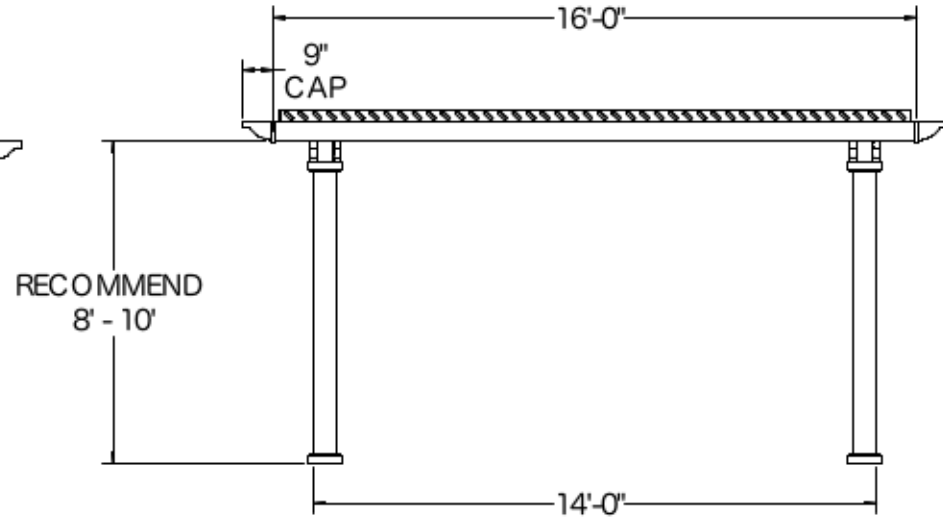

Center of Post to Structure Measurement

5" Square Post	163"
7" Square Column	157 1/2"
7" Round Column	157 1/2"
10" Round Column	155 3/4"

16' x 14' FREESTANDING PERGOLA

zenpergolas.com

1-800-430-1690



PLAN VIEW

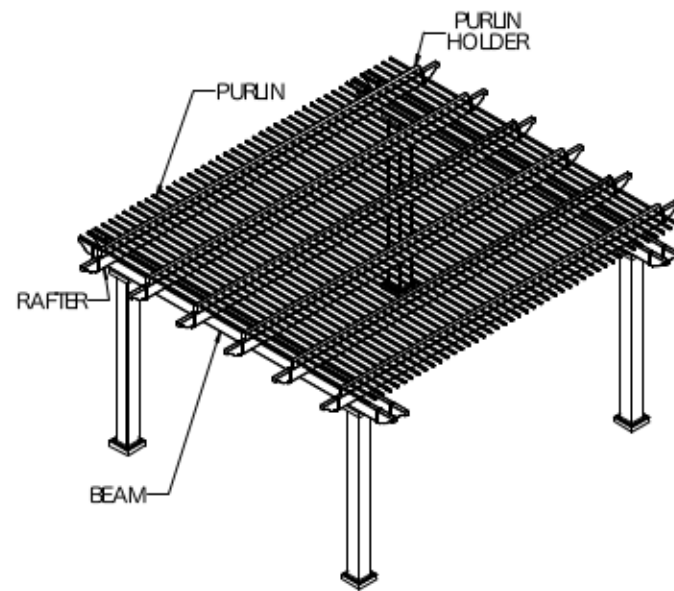
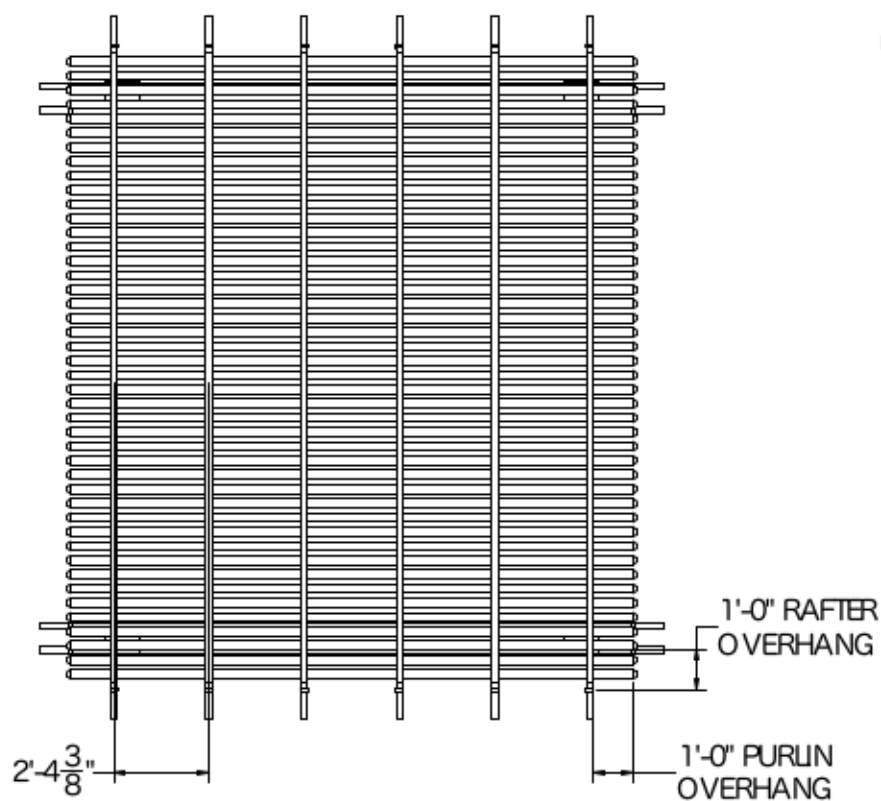

STRUCTURAL COMPONENTS

DESCRIPTION	QTY.
7" COLUMN ASSY WITH POSTMOUNT	4
2 x 6 BEAM WITH ALUMINUM INSERT	4
2 x 6 RAFTER WITH ALUMINUM INSERT	6
2 x 6 PERGOLA CAP	20
2 x 3 1/2 PURLIN HOLDER	6
2 x 3 1/2 FLATCAP	12
7/8 x 3 PURLIN (STD SPACING)	44
7/8 x 3 PURLIN CAP (STD SPACING)	88

16' x 14' FREESTANDING PERGOLA

zenpergolas.com

1-800-430-1690

